

INSTRUCTION SHEET

Fixing FMC-CBL base for columns

- Drill holes in the floor with an 8 mm tip, using the FMC-CBL plate (fig. 1) as drilling template.

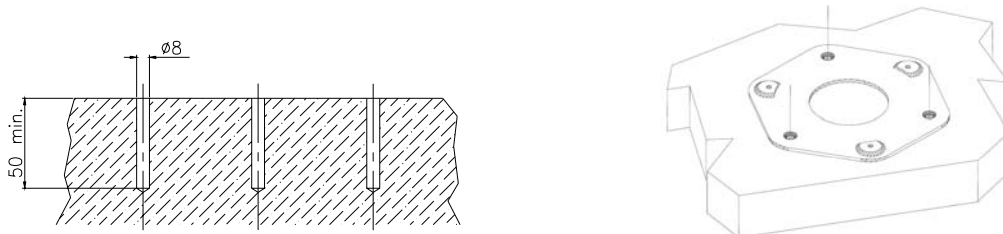

Fig.1

- Fix the plugs leaving them to project from the floor respecting the dimension indicated (fig.2);

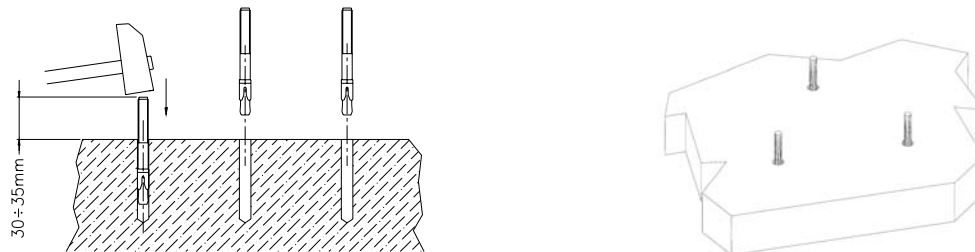

Fig.2

- Screw hexagonal nuts with washers as shown (fig.3);
- The first hexagonal nuts, preceded by the washers serve to anchor the plugs to the floor.

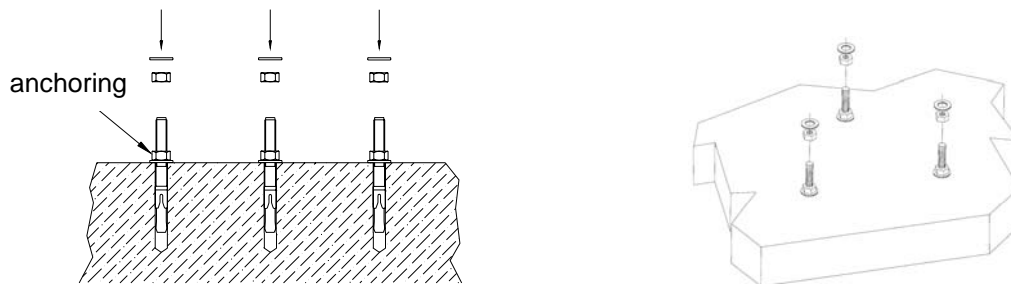

Fig.3

- The second hexagonal nuts followed by the washers serve to rest the plate (fig.4);

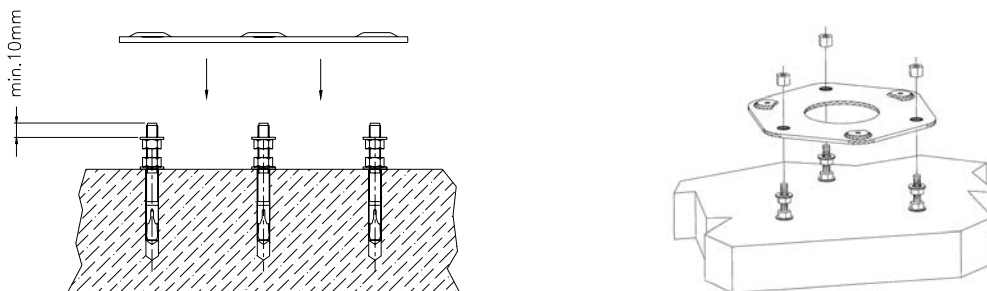

Fig.4

- Place the FMC-CBL base on the plugs, verify they are perfectly level and if necessary work on the hexagonal nuts to increase or decrease height of the plate (fig.5);

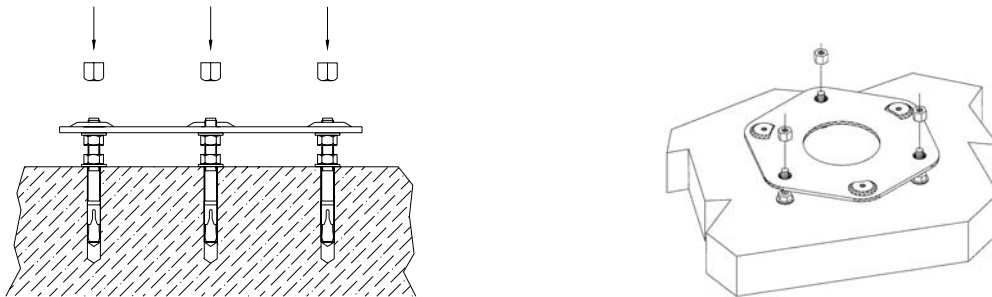

Fig.5

- Fix the plate with the three hexagonal nuts high (fig.6);

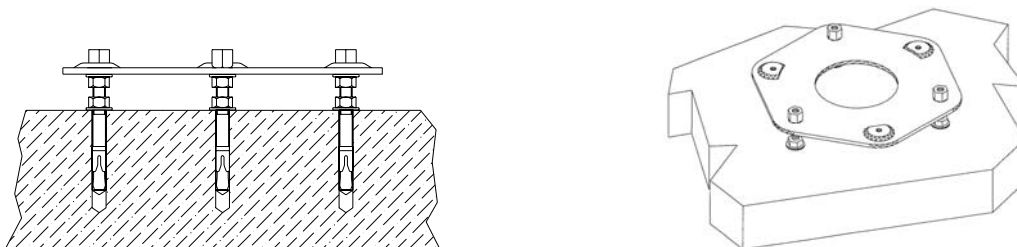

Fig.6

- Position the FMC column on the base with the three screws and washer, adjust the angle of the column as desired and fasten (fig.7);

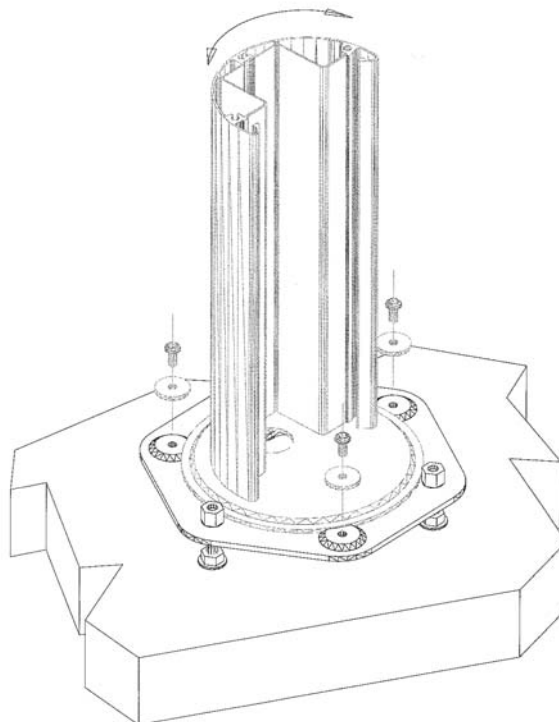

Fig.7